

DC/AC Current Probes UT-P4000 Series

UT-P4030D 30A/ DC~100MHz

UT-P4150 150A/ DC~12MHz

UT-P4500 500A/ DC~5MHz



Safety Notices

CAUTION

A CAUTION notice denotes a hazard. It calls attention to an operating procedure, practice, or the like that, if not correctly performed or adhered to, could result in damage to the product or loss of important data. Do not proceed beyond a CAUTION notice until the indicated conditions are fully understood and met.

WARNING

A WARNING notice denotes a hazard. It calls attention to an operating procedure, practice, or the like that, if not correctly performed or adhered to, could result in personal injury or death. Do not proceed beyond a WARNING notice until the indicated conditions are fully understood and met.

Catalog

Safety Notices.....	2
Catalog.....	3
1. Features and Applications.....	4
2. Description of products.....	5
3. Making Measurements.....	6
4. Safe Probing.....	7
5. Accessories Description.....	10
6. Specification.....	10
6.1 Electrical characteristics.....	10
6.2 Mechanical characteristic.....	13
6.3 Environmental characteristic.....	14
7. Operating Method.....	14
7.1 Preparation before testing.....	15
7.2 Degaussing and Zero setting.....	15
7.3 Measuring method.....	15
8. The method to deal with abnormal situation.....	16
9. Q&A.....	16
9.1 Does UT-P4000 series fit the oscilloscope of any brand?.....	16
9.2 Can UT-P4000 series product measure small current?.....	16
9.3 Anymore tips?.....	16
10. Packing list.....	17

1. Features and Applications

The **UT-P4000** series current probes are wide band width DC/AC active current probes, featuring high bandwidth, fast and accurate capture the current wave, accuracy up to 1% and low circuit insertion loss. This probe can be used with any oscilloscope having a high-impedance BNC input.

The key features include:

- ◆ Highly accurate current measurements.
- ◆ Wide bandwidth.
- ◆ Accurate and easy current measurements.
- ◆ DC/AC measuring capabilities.
- ◆ Over-current protection with dual indicators (buzzer and LED).
- ◆ High and low range selection.
- ◆ Low current measurements.
- ◆ Degaussing and automatic zero setting.
- ◆ Digital set by panel soft push keystroke for a longer service life.

Applications

- Switching and linear power design
- LED lighting design
- New energy resources
- Frequency conversion household appliances
- Experiment of electronic engineering
- Semiconductor devices design
- Inverters / transformer design
- Electronic ballast design
- Industrial control / consumer electronic design
- Engine driven design
- Power electronic and electrical drive experiment
- Electric vehicle transportation design

2. Description of products

UT-P4030D

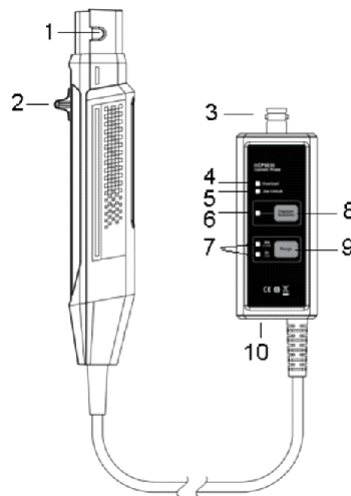

UT-P4150、UT-P4500

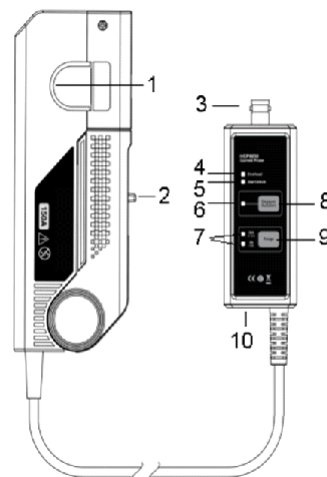

1) Sensor Head

The core component to measure conductor current. The component contains a precise semi-conductor that could be damaged by drastic change of environmental temperature, external pressure and shock. Please be careful during measurement.

2) Opening lever

The operating lever used to open the sensor head. Pull the lever to open the sensor jaw, put in the cable under test, and push the lever to lock the sensor head to measure the current.

3) BNC Output Connector

The standard BNC port that can be connected to oscilloscope of any brand by a standard BNC Coaxial Cable.

4) Overload Indicator LED

If when the current under measured exceeds the limit current, the red LED will light up and the buzzer will

sound an alarm.

5) Jaw on indicator

When the light is on, it means that the push rod is in the unlock state. Make sure that the jaw is in the lock state during the measurement.

6) Degaussing and Zero Setting Indicator

After pressing the degaussing zero button, the indicator light will be green, and after degaussing, the indicator light will be off. If degaussing setting succeeds, the buzzer will make two short beeps. If degaussing setting failed, the buzzer will make an extension beep of about one second.

7) Range LED Indicator

The green LED indicates the selected range.

8) Degauss auto zero button

Frequent usage of the device will generate residual magnetic field. Please degauss and zero set before measurement for better measurement precision. Press the degaussing and auto zero button to trigger the process (should be around 5s).

9) Range selected button

Model	Range	Transfer ratio
UT-P4030D	30A	0.1V/A
	5A	1V/A
UT-P4150	150A	0.01V/A
	30A	0.1V/A
UT-P4500	500A	0.01V/A
	75A	0.1V/A

10) Power supply socket

External power supply socket, standard with (12V/1A) adapter.

3. Making Measurements

Before using the probe, check that the system is safe and that the preparations described in Safe Probing.

- ✧ Have a visual inspection of the current probe of high frequency UT-P4000 Series probes, power supply, cable, and oscilloscope.
- ✧ The output of the current probe is terminated internally. Use a high impedance input to the measuring instrument. Be sure to set the input impedance to 1 MΩ before making measurements. Set the oscilloscope's input coupling to DC. With the oscilloscope input at ground, adjust the trace to the zero position. Connect the probe's output connector to the oscilloscope's input connector.
- ✧ Connect the power supply to probe and the power indicator will light. Select suitable Range you want via the Range Key.
- ✧ Ensure that the probe sensor is NOT clamped around any conductors. Slide the probe's Opening Lever

into the LOCKED position as shown in Figure. Confirm that the sensor head is properly closed.



❖ **Degaussing and Zero Setting**

When the key is pressed, the probe will demagnetize the core and set the output to zero voltage if it has been magnetized by switching the power on and off, or by an excessive input. Always carry out demagnetizing and Zero Setting before measurement and without current in the clamp. The demagnetizing and Zero Setting process takes about a few seconds. During demagnetizing and Zero Setting, a demagnetizing waveform is output.

If degaussing and Zero Setting succeeds, the buzzer will make two short beeps. If degaussing and Zero Setting failed, the buzzer will make a single sound, for one second.

Do not demagnetize while the conductor being measured is clamped. This could damage the components of the circuit being measured. Also, check that the conductor being measured is not clamped when supplying power to the current probe for the same reason. Demagnetized waveforms are generated when switching on the supply.

❖ **Measurement**

- ✚ Press the opening lever to open the sensor head.
- ✚ Align the sensor so that the probe's current direction indication corresponds to the direction of current flow through the conductor to be measured. Also, align the clamp so that the conductor is in the center of the sensor aperture.
- ✚ Press the opening lever on the sensor head until the UNLOCK indication disappears. Check that the opening lever is firmly locked, and the sensor head securely closed.

4. Safe Probing

This device is designed to comply with Safety Standards and has been thoroughly tested for safety prior to shipment. However, mishandling during use could result in injury or death, as well as damage to the device. Be certain that you understand the instructions and precautions in the manual before use. We disclaim any responsibility for accidents or injuries not resulting directly from device defects.

To avoid short circuits and potentially life-threatening hazards, follow these warnings and precautions:

WARNING

- ❖ Never attach the clamp to a circuit that operates over the maximum rated voltage to earth.
- ❖ Please avoid clamping around bare conductors during measurement.
- ❖ While clamping and measuring, do not touch the clamp in front of the barrier or the conductor being measured.
- ❖ Be careful to avoid damaging the insulation surface while taking measurements.

- ✧ Make sure that the waveform measuring equipment connected to this device's output terminal (BNC) is equipped with a protective earthing with double-insulation construction.
- ✧ Do not allow the device to get wet, and do not take measurements with wet hands. This may cause an electric shock.
- ✧ If the waveform measuring instrument being connected to the output terminal (BNC) on this device is equipped with any other measurement terminals, take the following precautions to ensure that the other instrument does not form a bridge between the probe and any hazardous live part of a part.

Isolate the terminal to which the probe is connected from other terminals on the measuring instrument using basic insulation conforming to the measurement category, working voltage, and pollution degree requirements of the circuit being tested.

If basic insulation requirements cannot be met between the terminal to which this device is connected and other terminals of the measuring instrument, make sure that the voltage input to the measurement terminal does not exceed the Separated Extra-Low Voltage Earthed.

Read and observe all warnings and precautions relating to electrical safety for the measuring instrument being connected to the probe.

CAUTION

- ✧ To avoid damage to the device, protect it from vibration or shock during transport and handling, and be especially careful to avoid dropping.
- ✧ Do not store or use the device where it could be exposed to direct sunlight, high temperature, humidity, or condensation. Under such conditions, the device may be damaged and insulation may deteriorate so that it no longer meets specifications.
- ✧ Before using the device the first time, verify that it operates normally to ensure that no damage occurred during storage or shipping. If you find any damage, contact your dealer or CYBERTEK representative.
- ✧ This device is not designed to be entirely water- or dust- proof. To avoid damage, do not use it in a wet or dusty environment.
- ✧ The sensor head is a precision assembly including a molded component, a ferrite core, and a Hall Effect element. It may be damaged if subjected to sudden changes in ambient temperature, or mechanical strain or shock, and therefore great care should be exercised in handling it.
- ✧ The matching surfaces of the sensor head are precision ground, and should be treated with care. If these surfaces are scratched, performance may be impaired.
- ✧ Foreign substances such as dust on the contact surfaces of the sensor head can cause acoustic resonance and degrade measurement, so it should be cleaned by gently wiping with a soft cloth.
- ✧ To avoid damaging the sensor cable and power supply cable, do not bend or pull the cables.
- ✧ When the power is on, keep closed, except when clamping them onto the conductor to be

measured. The facing surface of the core section can be scratched while it is open.

- ✧ Do not place any un-clamped conductor with an electric current of a frequency of 10 kHz or more near the sensor head. Current flowing in the conductor nearby may heat up the sensor head and cause its temperature to rise, leading to damage to the sensor. For example, when one side of a go-and-return conductor is clamped and the other side is also placed near the sensor head, even if the electric current is lower than the consecutive maximum current, electric currents in both sides will heat up the wires and raise the temperature, thereby causing damage to the sensor.
- ✧ The maximum continuous input range is based on heat that is internally generated during measurement. Never input current in excess of this level. Exceeding the rated level may result in damage to the probe.
- ✧ The maximum continuous input range varies according to the frequency of the current being measured.
- ✧ If excess current is input, generated heat activates a built-in safety function that blocks normal output. If this happens, remove the input immediately (remove the sensor from the conductor being measured or reduce the input current to zero). Wait until the sensor has had sufficient time to cool before resuming operation.
- ✧ Even if the input current does not exceed the rated continuous maximum, continuous input for an extended period of time may result in activation of the safety circuit to prevent damage resulting from heating of the sensor.
- ✧ At high ambient temperatures, the built-in safety circuit may activate at current input levels below the rated continuous maximum.
- ✧ Continuous input of current exceeding the rated maximum or repeated activation of the safety function may result in damage to the unit.
- ✧ The probe is rated for maximum input under two conditions in addition to the input maximums shown in the Specifications. These are (1) 30A peak for non-continuous input and (2) 50A peak for pulse widths 10 μ s.
 - (1) indicates an upper waveform response limit of 30A peak. Use the sensor at RMS current input levels that are within the rated continuous maximums.
 - (2) Indicates the upper response limit for a single input pulse.
- ✧ When opening the sensor head of the probe, be sure to operate with the opening lever. If an upper core is forced to open when the sensor head is locked, the open close mechanism can be damaged.

NOTE

- ✧ The output of this unit is terminated internally. Use an oscilloscope with an input impedance of at least 1 M Ω .
- ✧ Immediately after powering on the probe, the probe may be subject to an appreciable offset drift due to the effect of self heating. To counteract this, allow the probe to warm up for about 30 minutes before carrying out measurement.
- ✧ When performing continuous measurements, it is necessary to be aware that the offset voltage drifts, depending on factors such as the ambient temperature.

- ✧ Under certain circumstances, oscillation may occur if the probe is connected to the power supply while the power supply is on. This does not indicate a malfunction. Oscillation can be stopped and operation restored to normal by opening and closing the sensor head.
- ✧ Depending on the measured current frequency, some sound maybe produced by resonance, but has no effect on measurements.
- ✧ The reading may be affected by the position within the clamp aperture of the conductor being measured. The conductor should be in the center of the clamp aperture.
- ✧ When carrying out a measurement, press the opening lever until the UNLOCK indication disappears and check that the sensor head is properly closed. If the sensor head is not properly closed, an accurate measurement is not possible.
- ✧ Accurate measurement may be impossible in locations subject to strong external magnetic fields, such as transformers and high-current conductors, or in locations subject to strong external electric fields, such as radio transmission equipment.
- ✧ At high frequencies, common mode noise may affect measurements taken on the high voltage side of circuits. If this occurs, reduce the frequency range of the waveform measuring instrument or clamp onto the low-voltage side of the circuit.

5. Accessories Description

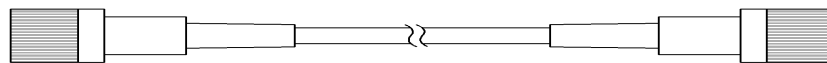

BNC Cable: 100cm, MALE X MALE

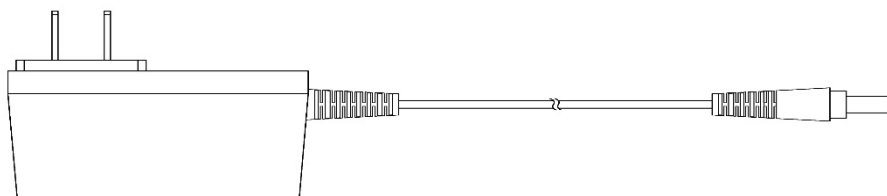

Power Adapter (12V/1A)

6. Specification

6.1 Electrical characteristics

Model	UT-P4030D	UT-P4150	UT-P4500
Bandwidth(-3dB)	DC-100MHz (Figure1)	DC-12MHz (Figure4)	DC-5MHz (Figure7)

Rise time	$\leq 3.5\text{ns}$		$\leq 29\text{ns}$		$\leq 70\text{ns}$	
Continuous maximum input range	30Arms (Figure2)		150Arms (Figure5)		500Arms (Figure8)	
Max peak current value	50Apk		300Apk		750Apk	
Range (RMS)	5A(1X)	0.05A~5A	30A(10X)	0.3A~30A	75A(10X)	0.3A~75A
	30A(10X)	0.3A~30A	150A(100X)	1.5A~150A	500A(100X)	5A~500A
Overload	5A	$\geq 5\text{Apk}$	30A	$\geq 30\text{Apk}$	75A	$\geq 75\text{A}$
	30A	$\geq 50\text{Apk}$	150A	$\geq 300\text{Ap}$	500A	$\geq 750\text{A}$
Current transfer ratio	5A	1V/A	30A	0.1V/A	75A	0.1V/A
	30A	0.1V/A	150A	0.01V/A	500A	0.01V/A
Measurable current	5A	1mA	30A	10mA	75A	10mA
	30A	10mA	150A	100mA	500A	100mA
Amplitude accuracy (DC,45-66Hz)	5A	$\pm 1\% \pm 1\text{mA}$	30A	$\pm 1\% \pm 10\text{mA}$	75A	$\pm 1\% \pm 10\text{mA}$
	30A	$\pm 1\% \pm 10\text{mA}$	150A	$\pm 1\% \pm 100\text{mA}$	500A	$\pm 1\% \pm 100\text{mA}$
Input impedance	Reference (Figure3)		Reference (Figure6)		Reference (Figure9)	
Delay time	Probe	14ns		36ns		42ns
	BNC(1m)	5ns				
Terminal load	$\geq 100\text{k}\Omega$					
Power supply	DC 12V/1A (Standard Adaptor)					
Voltage of insulated	300V CAT I		600V CATII 300V CATIII			

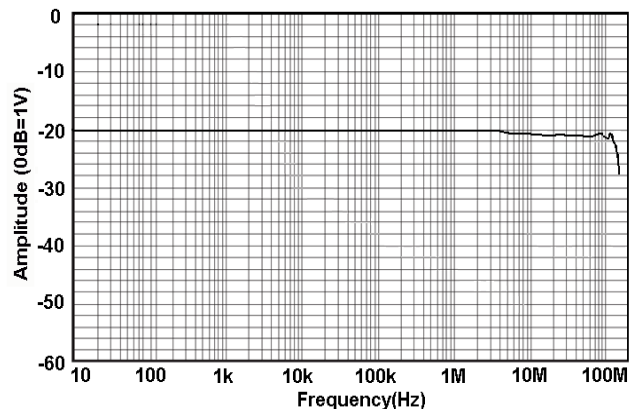

Figure1 UT-P4030D Amp- Frequency curve

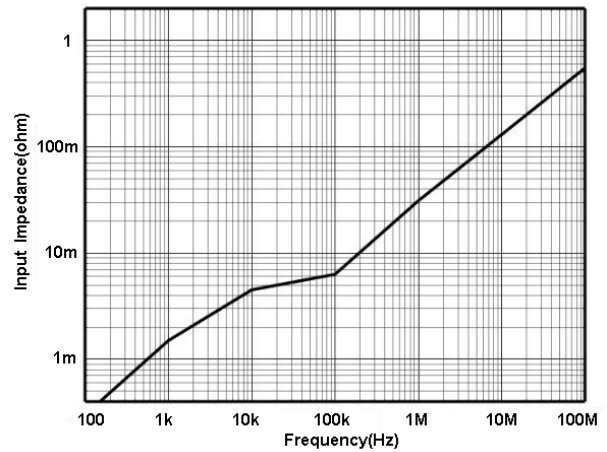
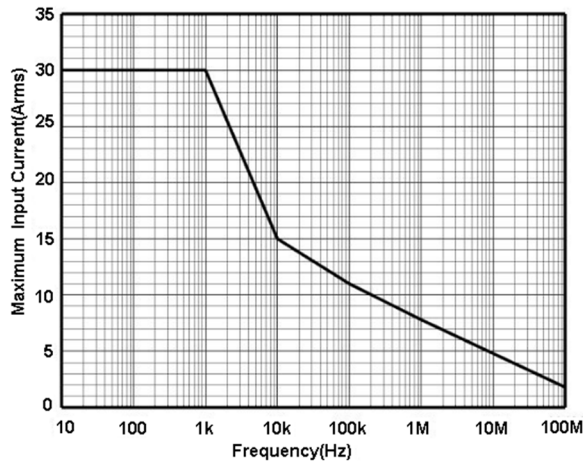

Figure2 UT-P4030D

Continuous maximum input measurement

Figure3 UT-P4030D

Input impedance VS Frequency curve

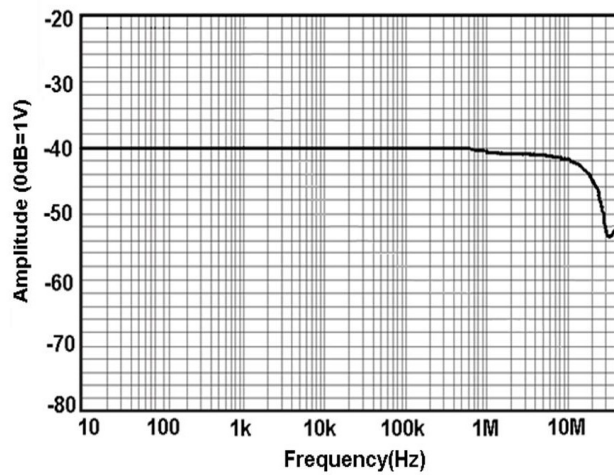

Figure4 UT-P4150 Amp- Frequency curve

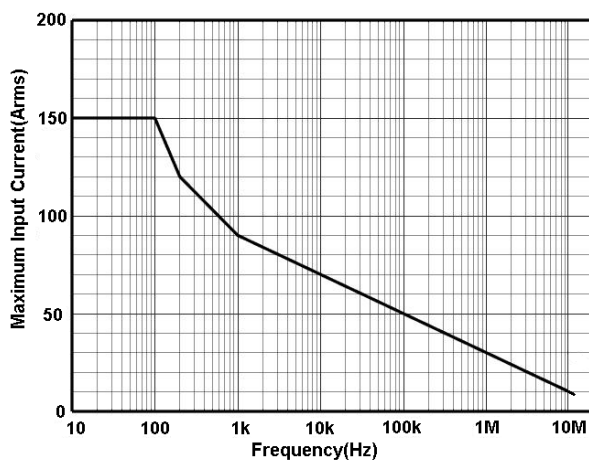

Figure5 UT-P4150

Continuous maximum input measurement

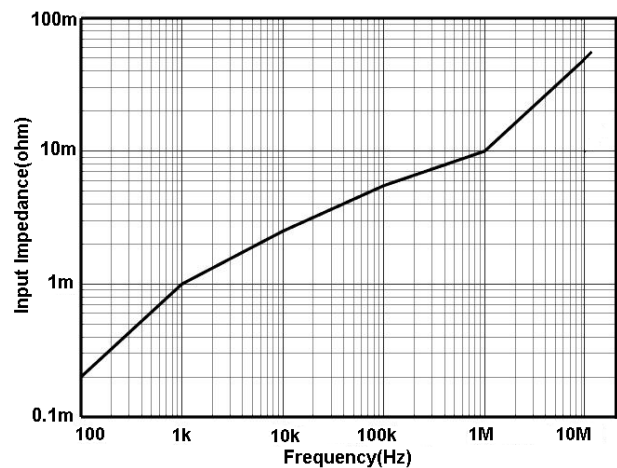

Figure6 UT-P4150

Input impedance VS Frequency curve

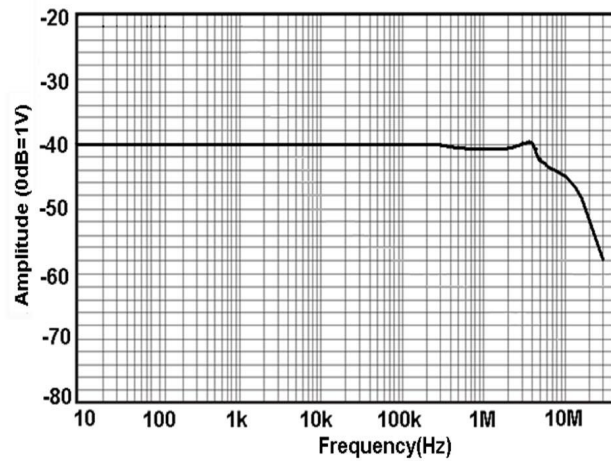

Figure7 UT-P4500 Amp- Frequency curve

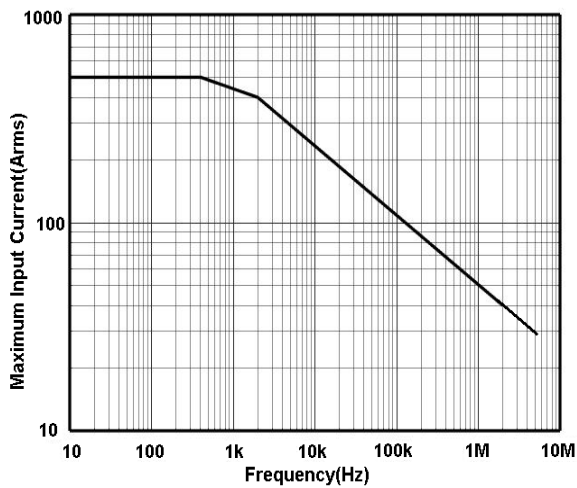

Figure8 UT-P4500

Continuous maximum input measurement

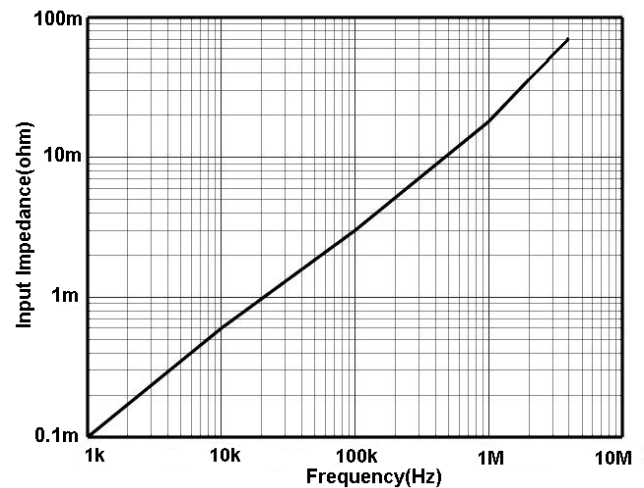

Figure9 UT-P4500

Input impedance VS Frequency curve

6.2 Mechanical characteristic

Model	UT-P4030D	UT-P4150	UT-P4500
Measurement conductor diameter max.	5mm	20mm	
Cable length	1m	1.5m	
BNC Cable length	100cm		
Adapter dimensions	62*58*29mm line: 1.5m		
Clamp dimensions (L*W*H)	176*39.5*18mm	174*67.5*30mm	
Termination unit (L*W*H)	91.5*40*26.5mm		

Probe weight	255g	555g	525g
--------------	------	------	------

6.3 Environmental characteristic

Operating temperature and humidity	0-40°C, ≤80% RH
Storage temperature and humidity	-10-50°C, ≤80% RH
Operating altitude	≤2000m
Storage altitude	≤12000m

7. Operating Method

Note

- ✧ The output interface of this machine is set inside. When using the oscilloscope, please select high input resistance (1MΩ). If the input resistance is 50Ω, the data will be incorrect.
- ✧ Please make sure the current measured doesn't surpass the maximum current. The magnetic core will saturate. The saturated magnetic core will neutralize the generate waveform during saturation. The overcharged inrush might cause mistaken degaussing and need to be zero set again.
- ✧ When power is connected, offset might occur because of the heat generated by the machine. But it will be stabilized after about 30 min.
- ✧ Strong magnetic field like transformer, large circuit, high electricity like wireless will cause deviation
- ✧ The voltage might deviate because of the surrounding temperature, so please be careful when testing sequentially
- ✧ The frequency of the current under test may cause resonance, but this won't influence the testing.
- ✧ The position of conductor under test in the sensor will influence the result, so please move the conductor under test into the center of the sensor.
- ✧ Push the switch control pole all the way through until the unlock mark disappear. Please make sure the control pole is locked and the entire structure is closed. If the entire structure isn't closed, the testing will go wrong.
- ✧ If you insert the high potential side of the circuit in high frequency domain, the result might be influenced by the noise. If it's necessary, please limit the waveform observer's frequency domain or insert the low potential side of the circuit.



Attention

- ✧ When disconnecting the output terminal, please pull out the connector after unlocking. The output terminal will be damaged if you force to drag the cable out before unlocking.
- ✧ When putting in the output terminal other than BNC terminal, please be careful for the polarity of the terminal.

- ☞ The continuous maximum input range is the fixed value caused by the machine's operating heat. Please do not put in current higher than this value, or the device will be damaged.
- ☞ The continuous maximum input range will change according to the frequency of the current under test. The probe will be damaged when operate under overcharged current .
- ☞ When the input current continuously surpasses the maximum input range, the self-protection will be activated by the heating of the sensor and cause wrong output. Please stop the current input and wait for full cool down before next operation.
- ☞ The protection circuit will be mistakenly activated by the high temperature even when the continuous current under test is below the max input.
- ☞ When the connect input surpass the max input range current and activate the protection function too often, the device may be damaged.
- ☞ You must open the entire part through switch controller.
- ☞ At the lock state, please do not press the entire part as shown below.

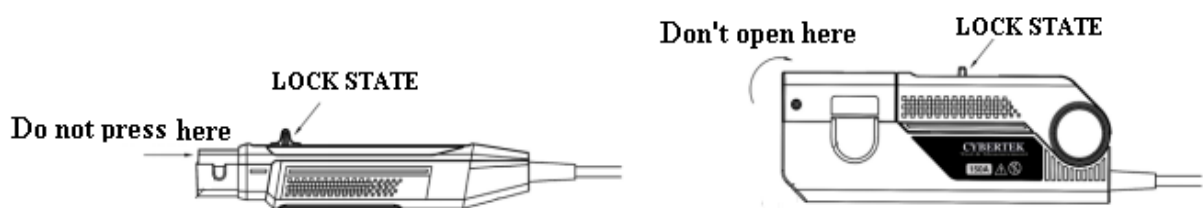

7.1 Preparation before testing

- ✧ Prepare the high frequency current probe UT-P4000 series, adapter and oscilloscope
- ✧ Power up the UT-P4000 probe and the green LED power indicator will be lighted.
- ✧ Set the oscilloscope: Ground the measuring mode, zero set the oscilloscope and turn the oscilloscope mode to DC mode.
- ✧ Choose the proper range according to the current under test. The default setting of the probe is large current range

7.2 Degaussing and Zero setting

- ☞ Connect the UT-P4000 with oscilloscope (Make sure the input impedance of the oscilloscope is 1MΩ)
- ☞ Lock the probe until the UNLOCK symbol disappear.
- ☞ Press the button to degauss and zero set. There will be beeping as success indication after 6s

7.3 Measuring method

- ✧ Confirm the previous steps
- ✧ Pull the switch control pole of the sensor, open the head of the sensor and make the current direction mark in front of the sensor accordance with the current under test, and put the conductor under test in the middle of the sensor.
- ✧ Push the switch control pole of the sensor until the UNLOCK mark disappear. Lock the probe, make sure the entire part is closed, and then observe the waveform under test. Utilize the current transfer ratio to transform the voltage sensibility into current sensibility. For instance, the ratio of

UT-P4030 is 0.1V/A (30A range), and then, when the voltage sensibility of the waveform monitor is 10mV/div, the current sensibility is 100mA/div.

8. The method to deal with abnormal situation

Situation	Possible reason	Dealing method
Can't measure DC, or the value obtained is comparatively low in the frequency range	Power is off	Turn on power
	Oscilloscope set to AC coupling	Set to DC coupling
	Sensor is not locked	Please lock the sensor
Auto degaussing or zero setting unsuccessful	The probe is on the operating circuit under test when degaussing or zero setting is applied	Turn off the circuit under test and zero set again.
The amplitude is comparatively low in the frequency range	The input resistance of the test equipment like oscilloscope is 50Ω	Set the resistance over 1MΩ

9. Q&A

9.1 Does UT-P4000 series fit the oscilloscope of any brand?

A: UT-P4000 series has standard BNC interface can be applied to the oscilloscope of any brand. It is powered by standard adapter, independent of oscilloscope power, so it is very easy to use.

9.2 Can UT-P4000 series product measure small current?

A: Yes. For now, the UT-P4000 series current probe has two optional ranges, and one is for small current. The current resolution of the UT-P4030(D) is 1mA. When measuring small current, please accurately zero set and degaussing the probe, and do not change the position of the probe hand grip. To observe the waveform please set the bandwidth restriction of the oscilloscope to 20MHz to eliminate the interference of noise. When measuring extremely small current (a few mA for example), one could make a few more loop of cable around the probe and divide the result with number of loop to obtain the actual current value.

9.3 Anymore tips?

- ✧ When measuring high frequency current, please do not let the current surpass the value shown by the curve of max peak current vs frequency. The max continuous current over the curve will burn the probe.
- ✧ To measure accurately, please degauss and zero set the probe, and make sure the probe is locked during the process.
- ✧ Set the input impedance of the oscilloscope to 1MΩ(default)

- ✧ Make sure the probe is locked during testing.
- ✧ The probe should be away from the interference source like transformer. The method to judge if the probe is interfered is to put the probe close to circuit under test. IF there's any output, there could be interference in the testing environment because the probe is not on the circuit yet.
- ✧ The current under test should not surpass the limit value of the probe.
- ✧ Please always maintain your probe and do not use it in the humid environment
- ✧ If there's anything wrong with the probe, please set it back for repairing. If you dismantled the device on your own, we won't guarantee for repairing.

10. Packing list

Packing list	
ITEM	Quantity
Probe	1
DC-12V/1A adapter	1
BNC connecting line	1
Instruction manual	1
Guarantee card	1
Test report	1