

TENMARS

UV-AB Meter

TM-223



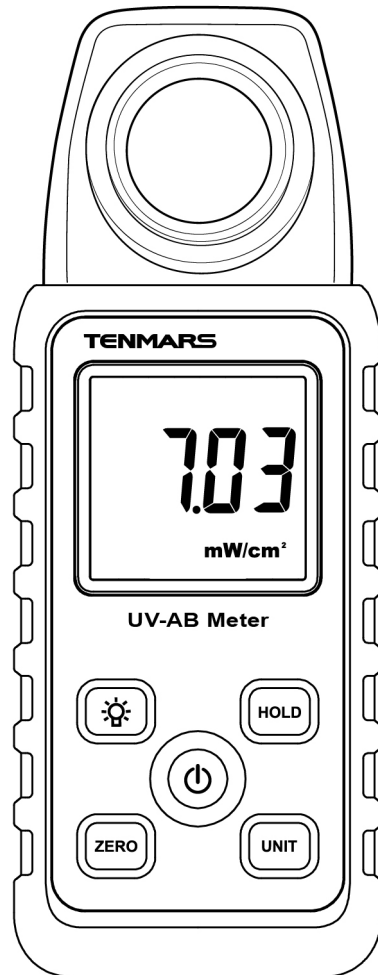

TM-213

User's Manual



HB2TM2230000

CONTENTS

1.	Introduction	1
2.	Accessories	1
3.	Safety Precaution	2
4.	Instrument Description	3
4.1.	The LCD display SHOWS	3
4.2.	Buttons:.....	3
5.	General Specifications:	4
6.	Electrical Specifications	4
7.	Operation	5
7.1.	Power button.....	5
7.2.	 Button	5
7.3.	 Button	5
7.4.	 button.....	5
7.5.	 Data hold button.....	5
8.	Maintenance or Repair.....	6
9.	Battery Replacement.....	7
10.	Product Disposal	7

1. Introduction

Please, read the operating instructions in details before you use this UVAB optics meter, so you will operate the meter correctly. This meter can be used in industry and home.



Application:

- Monitoring blue light radiation hazards in welding.
- UV sterilization.
- Graphic arts.
- Photochemical matching.
- UV EPROM erasure.
- Photos resist exposure.
- Curing of inks, adhesives and coatings.
- Convenient, no need to adjust, data displayed clearly.
- Weathering "degradation studies".
- UV sterilization.
- Virology.
- Microbial genetics.
- DNA research.
- Biologic hoods.
- General laboratory use.

2. Accessories

- | | |
|---|------------------------------------|
| 1 | Meter |
| 1 | Carrying case |
| 1 | User's Manual |
| 2 | Battery 1.5V(AAA MN2400 LR03 AM4) |

3. Safety Precaution

	Caution! Please refer to this manual. Improper use may damage the meter and its components.
	Complies with European Directive.

- Do not operate in environments with flammable gas or humid environments.
- Operating altitude: up to 2000M.
- Operating environment: Indoor use; Pollution degree 2.
- Clean with soft cloth when dirty, such as glasses cloth. Do not clean with chemicals and other solvents.
- EMC: EN61326-1:CISPR 11:Group 1, Class B
- ✧ Class B – Equipment for use in all establishments other than domestic.
- ✧ Group 1 – RF energy generated is needed for internal functioning.

4. Instrument Description

4.1. The LCD display SHOWS

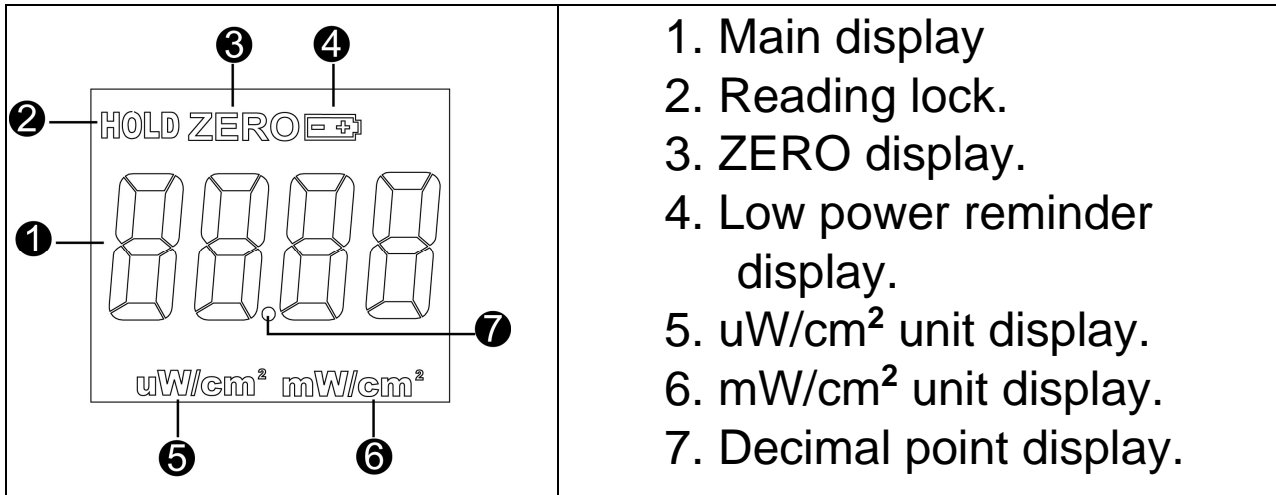

4.2. Buttons:

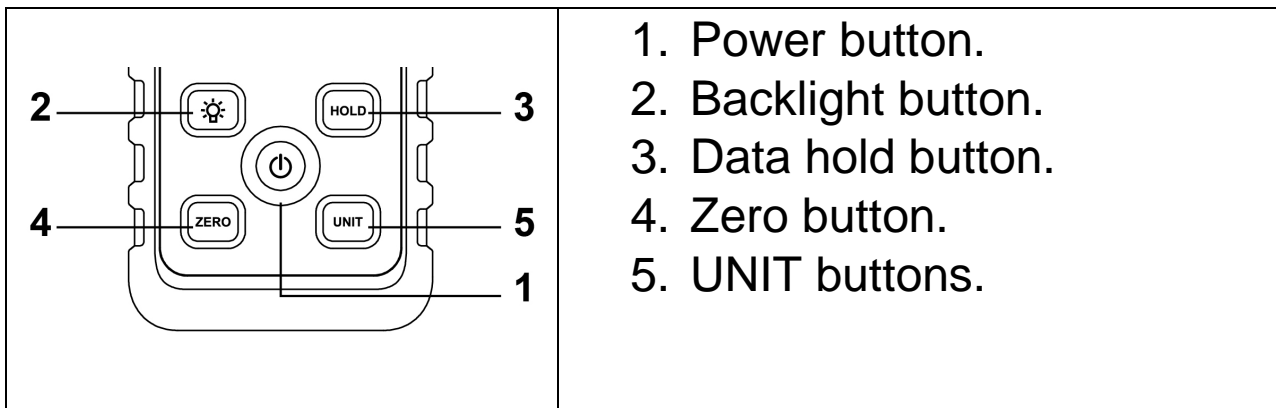

5. General Specifications:

- Zero function.
- 1uW/cm² or 1.00mW/cm² unit selection.
- Data hold.
- Back light: it will turn off automatically after turned on for 15 seconds .
- Low battery indication
- Overload display: “OL”.
- Low battery indication "☐+ -":
- Auto power off of 15 minutes.
- Operating : Temperature 5°C~40°C, below 80%RH.
- Storage temp. & RH : -10°C~60°C, below 70%RH.
- Sensor: UV light sensor.

6. Electrical Specifications

DISPLAY	3-3/4 digits LCD with maximum reading 4000
Measuring range	4000 μ W/cm ² ,20mW/cm ²
Resolution	1μw/cm ² ,0.01mW/cm ²
Accuracy	± 4(%FS + 2dgt) FS: full scale 15%:sunlight ultraviolet.
Spectrum Range	290~390nm
Calibration Point	365nm
Sample Time	Approx. 3 sec.
Power Supply	2 batteries 1.5V
Battery life	approx. 50 hr.
Weight	approx. 90g..
Size	133(L) x 48(W) x 23 (H)mm

7. Operation

7.1. Power button

Press the “” button to turn ON or turn off.

7.2. Button

Press the “” button for the zero adjustment if any digits are appearing. When the lid of the light receiving part is not opened, if it is found that it is not zeroed

7.3. Button

Press “” key backlight light on.

Backlight light turns off automatically after 15 seconds.

7.4. button

Press the “” button to switch from $\mu\text{W}/\text{cm}^2$ to mW/cm^2 .

7.5. Data hold button

Press  to enable or disable the data hold function.

8. Maintenance or Repair

1. When the When “” symbol is displayed on the LCD, it means that there is insufficient power; please change the battery immediately in order to ensure its accuracy.
2. Do not place the meter in locations that have high temperature, humidity or that are exposed to direct sunlight.
3. Remember to turn off the power after usage; remove the battery if not used for a long period of time in order to prevent battery leakage and causing damages to internal components.
4. When the instrument failure, only by the authorized service provider or return the original repair.

9. Battery Replacement

1. Turn off the power.
2. Open the battery cover at the back of the meter, remove the batteries.
3. Please insert new 1.5V x 2 batteries according to the polarities.
4. Put the battery cover back in place.

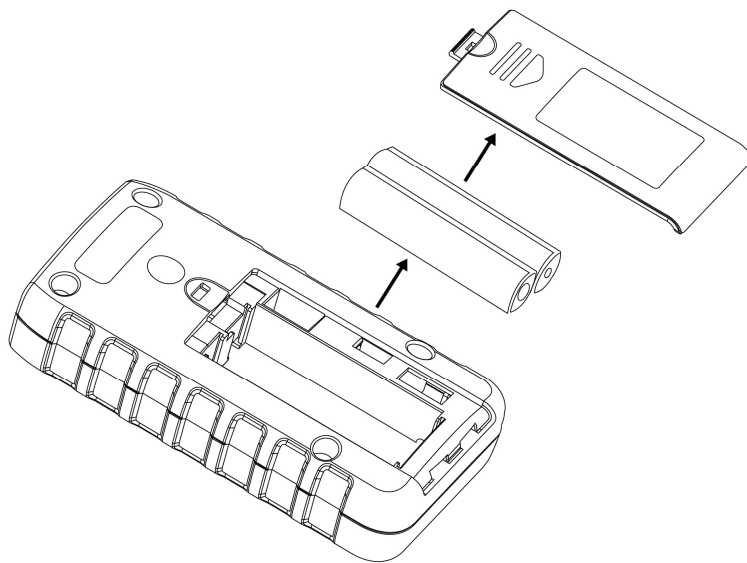

10. Product Disposal



Note: This symbol indicates that the meter and its accessories must be separated and processed properly.

TENMARS



Professional Electrical and Environment Test & Measurement Instruments:

Professional Electrical and Environment Test & Measurement Instruments:

LED light meter, Temperature & Humidity meter, Infrared Thermometer, Sound level meter, Light meter, EMF meter, UV Light meter, RF meter, Hot wire Anemometer, Co meter, Anemometer, Lan cable tester, Co2 meter, Solar power meter, Radiation meter, Clamp meter, Multimeter, Phase Rotation test, Digital Insulation tester

**Our products of high quality are selling well
all over the world**

TENMARS ELECTRONICS CO., LTD.

6F, NO.586 Ruiguang Rd, Neihu Dist.

Taipei City, Taiwan

E-mail: service@tenmars.com

<http://www.tenmars.com>