



KERN & Sohn GmbH

Ziegelei 1

D-72336 Balingen

E-Mail: info@kern-sohn.com

Tel: +49-[0]7433- 9933-0

Fax: +49-[0]7433-9933-149

Internet: www.kern-sohn.com

Operating instruction Compact balance

KERN FOB

Version 1.8

01/2011

GB



FOB-BA-e-1118



KERN FOB



Version 1.8 01/2011

Operation instruction

Compact balance

Table of contents:

1	Technical data	4
1.1	Verifiable models.....	4
1.2	Non verifiable models	6
2	Fundamental information (general)	8
2.1	Intended use	8
2.2	Inappropriate use	8
2.3	Guarantee.....	8
2.4	Monitoring the test substances	9
3	Fundamental safety information	9
3.1	Observe the information in the operating instructions.....	9
3.2	Staff training	9
4	Transport and storage	9
4.1	Acceptance check	9
4.2	Packaging / return transport	9
5	Unpacking, installation and commissioning	10
5.1	Place of installation, place of use.....	10
5.2	Installation.....	11
5.2.1	List of items supplied	11
5.3	Mains supply	11
5.4	Rechargeable battery operation (optional).....	11
5.5	Initial start-up.....	11
5.6	Adjustment	12
5.7	Adjusting	12
5.7.1	Verifiable Models FOB 1K1M, FOB 2K2M, FOB 5K5M	12
5.7.2	Verifiable Models FOB 6K2LM, FOB 15K5LM, FOB 30K10LM	12
5.7.3	Non-verifiable Models.....	13
5.7.4	Check software settings for verification of a balance.....	13
5.7.5	Position adjust switch	15
5.8	Verification	15
5.8.1	Position of the „security marks“	16

6	Operation	17
6.1	Overview of display	17
6.1.1	Verifiable models.....	17
6.1.2	Non-verifiable models.....	17
6.2	Weighing	18
6.3	Taring ( key).....	18
6.4	Zeroing the balance ( ->verifiable balances).....	18
6.5	Plus/minus weighings	19
6.6	Net/gross weighings	19
6.7	Auto OFF mode	19
6.8	Unit change	19
7	Maintenance, upkeep, disposal	20
7.1	Cleaning.....	20
7.2	Maintenance, upkeep.....	20
7.3	Disposal.....	20
8	Troubleshooting	21

1 Technical data

1.1 Verifiable models

KERN	FOB 1K1M	FOB 2K2M	FOB 5K5M
Readout (d)	1 g	2 g	5 g
Weighing range	1kg	2 kg	5 kg
Taring range (subtractive)	1kg	2 kg	5 kg
Adjustmentweight (not included) (class)	1000g (M1)	2000 g (M3)	5000 g (M3)
Stabilization time	2 sec.		
Operating temperature	0° C + 40° C		
Air humidity	25 - 95 % (non-condensing)		
Case (W x D x H) mm	175 x 235 x 60		
Weighing plate (W x D)mm	175 x 160		
Weight kg (net)	1,95		
Rechargeable battery (Option)	7.2 V; 1200 mAh; Working life approx. 24 h / Loading time approx. 8h		
Mains adapter	15V/500mA		

KERN	FOB 6K2LM	FOB 15K5LM	FOB 30K10LM
Readout (d)	2 g	1 g	2 g
Weighing range (Max)	6 kg	15 kg	30 kg
Taring range (subtractive)	6 kg	15 kg	30 kg
Reproduzierbarkeit	2 g	5 g	10 g
Linearität	± 4 g	± 10 g	± 20 g
Adjustmentweight (not included) (class)	5 kg (M3)	10 kg (M3)	20 kg (M3)
Stabilization time	2 sec.		
Operating temperature	-10° C + 40° C		
Air humidity	25- 95 % (non-condensing)		
Case (W x D x H) mm	220 x 305 x 80		
Weighing plate (W x D)mm	215 x 215		
Weight kg (net)	3,3		
Rechargeable battery (Option)	7.2 V; 1200 mAh; Working life approx. 24 h / Loading time approx. 8h		
Mains adapter	15V/500mA		

1.2 Non verifiable models

KERN	FOB 1.5K0.5	FOB 3K1	FOB 6K2
Readout (d)	0,5 g	1 g	2 g
Weighing range	1,5 kg	3 kg	6 kg
Taring range (subtractive)	1,5 kg	3 kg	6 kg
Reproducibility	0,5 g	1 g	2 g
Linearity	± 1 g	± 2 g	± 4 g
Adjustmentweight (not included) (class)	1000 g (M2)	2.000 g (M3)	5.000 g (M2)
Stabilization time	2 sec.		
Operating temperature	0° C + 40° C		
Air humidity	25 - 95 % (non-condensing)		
Case (W x D x H) mm	175 x 235 x 60		
Weighing plate (W x D)mm	175 x 160		
Weight kg (net)	1,95		
Rechargeable battery (Option)	7.2 V; 1200 mAh; Working life approx. 24 h / Loading time approx. 8h		
Mains adapter	15V/500mA		

KERN	FOB 7.5K0.5L	FOB 15K1L	FOB 30K2L
Readout (d)	0,5 g	1 g	2 g
Weighing range	7,5 kg	15 kg	30 kg
Taring range (subtractive)	7,5 kg	15 kg	30 kg
Reproduzierbarkeit	0,5 g	1 g	2 g
Linearität	± 1,5 g	± 3 g	± 6 g
Adjustmentweight (not included) (class)	5 kg (M1)	10 kg (M1)	20 kg (M1)
Stabilization time	2 sec.		
Operating temperature	0° C + 40° C		
Air humidity	25- 95 % (non-condensing)		
Case (W x D x H) mm	220 x 305 x 80		
Weighing plate (W x D)mm	215 x 215		
Weight kg (net)	3,3		
Rechargeable battery (Option)	7.2 V; 2000 mAh; Working life approx. 30 h / Loading time approx. 14h		
Mains adapter	15V/500mA		

2 Fundamental information (general)

2.1 Intended use

The balance you have acquired serves to determine the weighing value of the material to be weighed. It is intended to be used as a “non-automatic” balance, i.e. the material to be weighed is manually and carefully placed in the centre of the weighing plate. The weighing value can be read off after a stable weighing value has been obtained.

2.2 Inappropriate use

Do not use the balance for dynamic weighing. In the event that small quantities are removed or added to the material to be weighed, incorrect weighing results can be displayed due to the “stability compensation” in the balance. (Example: Slowly draining fluids from a container on the balance.)

Do not leave a permanent load on the weighing plate. This can damage the measuring equipment.

Be sure to avoid impact shock and overloading the balance in excess of the prescribed maximum load rating (max.), minus any possible tare weight that is already present. This could cause damage to the balance.

Never operate the balance in hazardous locations. The series design is not explosion-proof.

Structural alterations may not be made to the balance. This can lead to incorrect weighing results, faults concerning safety regulations as well as to destruction of the balance.

The balance may only be used in compliance with the described guidelines. Varying areas of application/planned use must be approved by KERN in writing.

2.3 Guarantee

The guarantee is not valid following

- non-observation of our guidelines in the operating instructions
- use outside the described applications
- alteration to or opening of the device
- mechanical damage and damage caused by media, liquids
- natural wear and tear
- inappropriate erection or electric installation
- overloading of the measuring equipment

2.4 Monitoring the test substances

The metrology features of the balance and any possible available adjusting weight must be checked at regular intervals within the scope of quality assurance. For this purpose, the answerable user must define a suitable interval as well as the nature and scope of this check. Information is available on KERN's home page (www.kern-sohn.com) with regard to the monitoring of balance test substances and the test weights required for this. Test weights and balances can be adjusted quickly and at a reasonable price in KERN's accredited DKD calibration laboratory (return to national normal).

3 Fundamental safety information

3.1 Observe the information in the operating instructions

Please read the operating instructions carefully before erecting and commissioning, even if you already have experience with KERN balances.

3.2 Staff training

The device may only be operated and looked after by trained members of staff.

4 Transport and storage

4.1 Acceptance check

Please check the packaging immediately upon delivery and the device during unpacking for any visible signs of external damage.

4.2 Packaging / return transport



- ⇒ Keep all parts of the original packaging for a possibly required return.
- ⇒ Only use original packaging for returning.
- ⇒ Prior to dispatch disconnect all cables and remove loose/mobile parts.
- ⇒ Reattach possibly supplied transport securing devices.
- ⇒ Secure all parts such as glass wind screen, weighing platform, power unit etc. against shifting and damage.

5 Unpacking, installation and commissioning

5.1 Place of installation, place of use

The balance is constructed in such a way that reliable weighing results can be achieved under normal application conditions.

By selecting the correct location for your balance, you will be able to work quickly and precisely.

Therefore please observe the following at the place of installation:

- Place the balance on a firm, level surface;
- Avoid extreme heat as well as temperature fluctuation caused by installing next to a radiator or in the direct sunlight;
- Protect the balance against direct draughts due to open windows and doors;
- Avoid jarring during weighing;
- Protect the balance against high humidity, vapours and dust;
- Do not expose the device to extreme dampness for longer periods of time. Inadmissible bedewing (condensation of air moisture on the device) can occur if a cold device is taken into a significantly warmer environment. In this case, please acclimatise the device for approx. 2 hours at room temperature after it has been disconnected from the mains.
- Avoid static charging of the material to be weighed, weighing container and windshield.

Major display deviations (incorrect weighing results) are possible if electromagnetic fields occur as well as due to static charging and instable power supply. It is then necessary to change the location.

5.2 Installation

Use the foot screws to level the balance until the air bubble in the bubble level is in the prescribed circle.

Notice : With non-verifiable models the air bubble is below the weighing plate.

5.2.1 List of items supplied

Standard accessories:

- Balance
- Weighing pan
- Mains adapter (15V/500mA, inside negative, outside positive pol)
- Operating instructions

5.3 Mains supply

Electric power supply is by means of the external mains supply circuit. The printed voltage level must comply with the local voltage.

Only use original KERN mains supply circuits. The use of other makes is subject to approval by Kern.

5.4 Rechargeable battery operation (optional)

The balance may only be operated via an optional rechargeable battery.

If in the display „**lobat**“ appears, the rechargeable battery capacity is exhausted.

Battery will be re-loaded via mains adapter. To use the full performance of the rechargeable battery, the battery should be loaded at least 14 hrs. before its first use. To save rechargeable battery life, the balance is equipped with an Auto OFF function.

This switches off the balance after a time of approximately 120 seconds after the last weighing or key operation.

5.5 Initial start-up

A warm-up time of 5 minutes stabilises the measured values after switching on.

The accuracy of the balance depends on the local acceleration of the fall.

Please be sure to observe the information in the chapter on adjusting.

5.6 Adjustment

As the acceleration value due to gravity is not the same at every location on earth, each balance must be coordinated – in compliance with the underlying physical weighing principle - to the existing acceleration due to gravity at its place of location (only if the balance has not already been adjusted to the location in the factory). This adjustment process must be carried out during the initial start-up, after change in location and variation of surrounding temperature. It is also recommendable to adjust the balance periodically during weighing operation in order to obtain exact measured values.

5.7 Adjusting



The accuracy of the balance can be checked and adjusted at any time with the help of weights.

Please note:



In a calibrated balance this adjustment option is inactive. (see chpt. 6.8 calibration).

Observe stable environment conditions. A short warming-up period of about 5 minutes for stabilization is useful.

5.7.1 Verifiable Models FOB 1K1M, FOB 2K2M, FOB 5K5M





- ⇒ Switch the balance on using the  key.
- ⇒ Press the adjust switch at the lower surface (see chap. 6.7.4) twice. A numerical value will appear on the display.
- ⇒ Now press the  key twice, “0” will appear on the display.
- ⇒ Place adjusting weight (for nominal value see “Technical data” capture 1) in the centre of the weighing plate and then press the  key. “CAL” will appear on the display for approx. 2 seconds, followed by the nominal value of the adjusting weight.
- ⇒ Remove the adjusting weight from the weighing plate to complete adjusting.

5.7.2 Verifiable Models FOB 6K2LM, FOB 15K5LM, FOB 30K10LM

- ⇒ Switch the balance on using the  key.
- ⇒ Press the adjustment switch on the bottom of the balance 4 times (see chap. 6.7.4), “CAL” is shown on the display.
- ⇒ Now press the  key, the word “Load” calibration weight will appear on the display (for nominal value see “Tech. Data” on chapter 1),
- ⇒ Place the weight on the middle of the weighing plate, then press the  key.
- ⇒ “CAL” will appear on the display for approx. 2 seconds, followed by the nominal value of the adjusting weight.
- ⇒ Remove the adjusting weight from the weighing plate to complete adjusting.

5.7.3 Non-verifiable Models

FOB 1.5K0.5, FOB 3K1, FOB 6K2, FOB 7.5K0.5L, FOB 15K1L, FOB 30K2L

- ⇒ Turn balance off and hold  key, test procedure appears on the display, operate the  -key 3x times during this test procedure.
- ⇒ Now let go of both keys. In the display appears “**CAL**”. Press key  in display appears “**Load**”.
- ⇒ Place the tare weight (nominal value, see “Techn. Specifications“ chapter 1) in the centre of the weighing pan, then press the key . “**CAL**” will appear on the display for approx. 2 seconds, followed by the nominal value of the adjusting weight.
- ⇒ Remove the adjusting weight from the weighing plate to complete adjusting.

5.7.4 Check software settings for verification of a balance

(only models FOB 1K1M, FOB 2K2M, FOB 5K5M):

For the adjustment function, the balance must be switched over to a service mode. This service mode is activated by actuating the adjustment switch twice.

In the service mode all parameters of the balance can be modified. There is a special setting named „TRAD“.

The service parameters may not be modified, as this could damage the balance settings.

Especially the setting „TRAD“ is very important for a verification. This setting activates and deactivates the verifiable settings of the balance.

Prior to a verification the setting „TRAD“ must be revised.

Press the  key and keep it pressed until „**A_OFF**“ appears on the display.

Press  button repeatedly. The setting „Trad“ must not appear (see graphic).

Overview of the possible software settings:
(there may be small differences referring to the model):

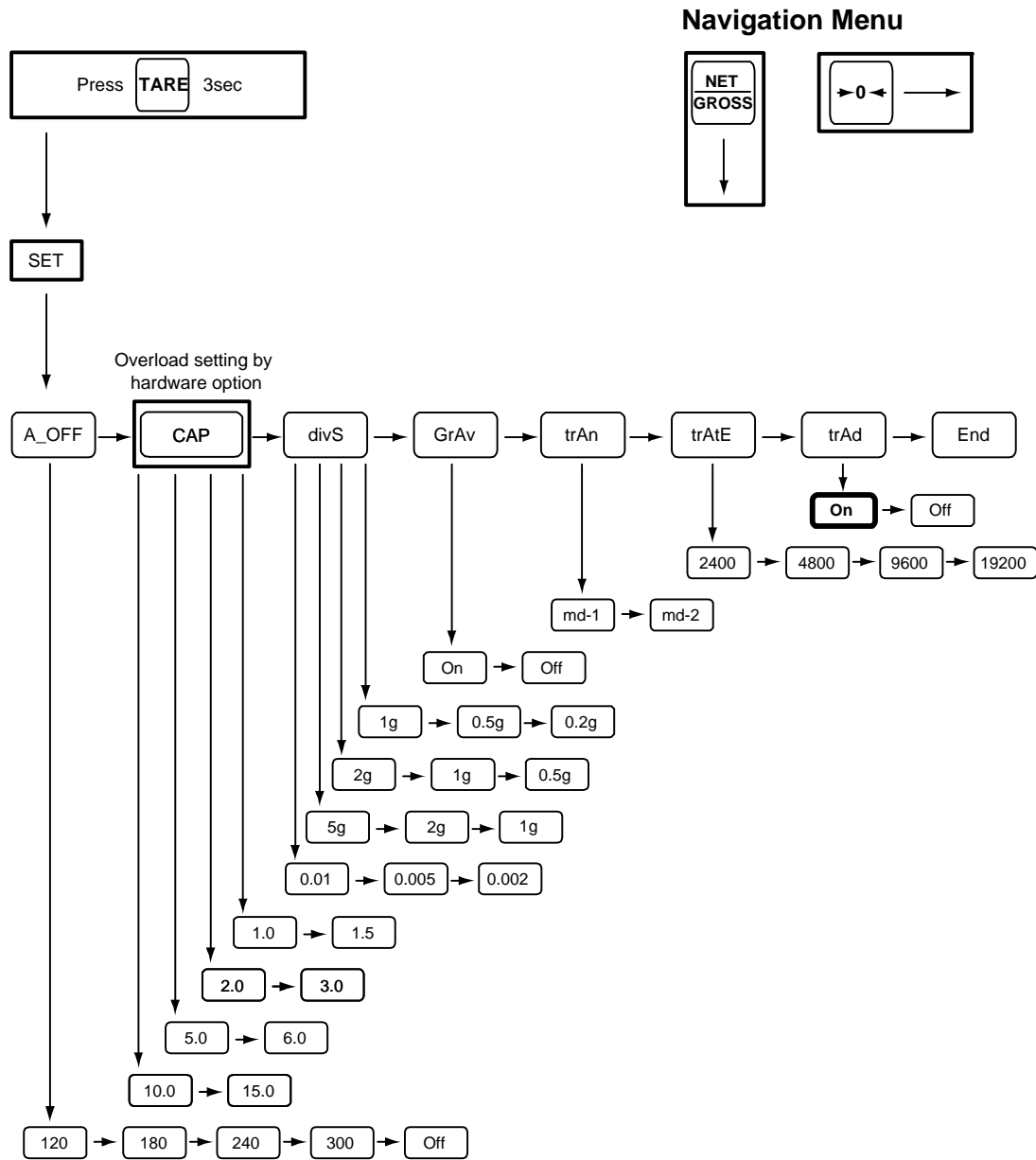

If the TRAD setting is **OFF**, this must be set to **ON** before a verification.
Reset into verifiable setting:

Press the **TARE** key and keep it pressed until „**A_OFF**“ appears on the display.

Press **>0<** key repeatedly until „**TRAD**“ appears.

Now press **NET GROSS** key, in the display appears “**OFF**”.

Now press the **>0<** key, „**ON**“ appears.

Then press subsequently **>0<**, **NET GROSS**, **>0<**.

The balance is now ready for verification.

In order to check the settings, repeat the process.

5.7.5 Position adjust switch

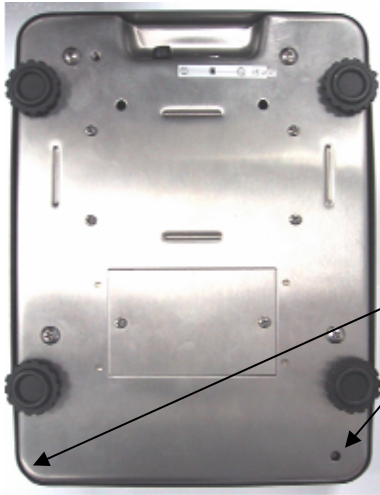

Adjust switch at the lower surface
(depending on the model, on the right
or the left side)

5.8 Verification

General:

According to the EU guideline 90/384/EEC balances must be verified if they are to be used as follows (legally regulated area):

- a) For commercial transactions if the price of goods is determined by weighing
- b) For the production of medicines in pharmacies as well as for analyses in the medical and pharmaceutical laboratory
- c) For official purposes
- d) For the production of finished packages

In case of doubt, please contact your local office of weights and measures.

Verification information

An EU qualification approval is available for those balances marked as appropriate for verification in the technical data. In the event that the balance is applied in an area subject to verification as described above, it must be verified and re-verified at regular intervals.

Re-verification of a balance is carried out in compliance with the respective legal provisions of the states. The term of verification validity for balances in Germany, for example, is normally 2 years.

The legal provisions of the country of use are to be observed.

5.8.1 Position of the „security marks“

The adjustment switch is inside the balance. After the verification process the balance is sealed on the marked positions.

The verification of the balance is not valid without the security mark.

Position of the „security marks“:



Balances that are subject to compulsory verification must be taken out of operation if:

- The **weighing result** of the balance is outside the **error limit**. Therefore, apply a known test weight (approx. 1/3 of the nominal load) to the balance at regular intervals and compare with the display value.
- The **reverification deadline** has been exceeded.

6 Operation

6.1 Overview of display

6.1.1 Verifiable models

FOB 1K1M, FOB 2K2M, FOB 5K5M:



FOB 6K2LM; FOB 15K5LM; FOB 30K10LM:



6.1.2 Non-verifiable models

FOB 1.5K0.5, FOB 3K1, FOB 6K2:





FOB 7.5K0.5L; FOB 15K1L; FOB 30K2L:



6.2 Weighing

Switch the balance on by pressing the  key.

The balance will show "88888" for approx. 3 seconds and then change to "0". Now it is ready for use.

Important: If the display does not show "0" press the  or  key (details in capture 7.2.2 or 7.2.3).

Only now (!) place object on the weighing pan. Make sure that the weighing object does not strike or touch the housing or base.

Now the weight will be indicated. After a successful „resting position“ control a small triangle will appear on the far right at the bottom of the display.

If the object should be heavier than the weighing range allowance, the symbol "E" (overload) will appear on the display and a tone can be heard.

6.3 Taring (key)

Switch the balance on by pressing the  key, then wait for the "0" indication.

Place the jiffy on the weighing pan and press the  key. Display again shows "0". Now the weight of the jiffy is memorised internally.

By pressing the  key after a weighing procedure, "0" will appear on the display again.

The taring procedure can be repeated continuously, for instance when mixing several components.

The limit is reached when the full weighing range is overlaid.

After having removed the jiffy the total weight will appear flashing as a minus indication.

6.4 Zeroing the balance (->verifiable balances)

Due to environmental influences, the balance may not display exactly "0.00" even when the weighing plate is empty. Nevertheless, you can zero the balance display at any time to ensure that weighing actually starts at zero. Zeroing with some weight on the balance can only be done within a certain range, depending on type. If the balance does not allow zeroing with the weight on the plate, the weight is out-of-range.

6.5 Plus/minus weighings

For example in order to check a single weight or for production control, etc.

Switch the balance on using the  key and wait until "0" appears on the display.

Place the target weight on the weighing plate and tare to "0" using the  key.

Remove the target weight.

Place the test samples on the weighing plate in succession. The respective target weight deviation is displayed as "+(*)" and "-".

(A preceding sign does not appear in the case of a "+" reading).

The same procedure can also be used to produce packages of the same weight in relation to a target weight.

Press the  key to return to weighing mode.

6.6 Net/gross weighings

This is useful when weighing in merchandise to be weighed in a tare container.

To control the total weight, the value of the tare container may be retrieved. This way it is possible to control to what extent the loading area of the balance is utilized. (gross, i. e. incl. weight of tare container).

Example:

Tare container (>2% of max) on weighing pan.

Tare by key , the display shows "0".

Place merchandise to be weighed on weighing pan, use the key  to change between gross weight (incl. tare container) and weight value of tare load.

Notice:

The tared load must be > 2% of weighing area (max.).

Values < 2% of max are not shown when using this function.

6.7 Auto OFF mode

For battery indulgence the balance is equipped with an auto-off function.

This automatically switches the balance off 120 seconds after the last weighing procedure or after a key has been operated.

6.8 Unit change

(only at models FOB 1.5K0.5; FOB 3K1; FOB 6K2)

Switch the balance on by pressing the  key, then wait for the "0" indication.

By pressing the  key, the units set in the balance can be selected between the different units.

The following units are available:

	Display	Conversion factor 1 g =
Gramm *	g	1.
Pound	lb	0.0022046226
Unze	oz	0.035273962

7 Maintenance, upkeep, disposal

7.1 Cleaning

Please disconnect the device from the operating voltage before cleaning.

Only use a cloth dampened with mild suds and not aggressive cleaning agents (solvents or similar). Please ensure that fluids are not able to get into the device and rub off using a clean, soft cloth.

Loose sample residue/powder can be removed carefully using a brush or hand vacuum cleaner.

Remove any spilt material to be weighed immediately.

7.2 Maintenance, upkeep

The device may only be opened by trained service engineers authorised by KERN. Disconnect from the mains supply before opening.

7.3 Disposal

The operating company shall dispose of the packaging and the device in compliance with the valid national or regional law of the operating location.

8 Troubleshooting

The balance should be switched off for a short time following an interruption in the programme sequence and disconnected from the mains supply. It is then necessary to repeat the weighing process from the beginning.

Help:

Interruption

Possible cause

Weight display is not illuminated.

- The balance is not switched on.
- The mains supply connection has been interrupted (mains cable not plugged in/faulty).
- Power supply interrupted.
- The rechargeable battery pack is empty.

The weight display changes continually

- Draught/air movement
- Table/floor vibrations
- The weighing plate is in contact with foreign matter.
- Electromagnetic fields / static charging (choose different location/switch off interfering device if possible)

The weighing result is obviously incorrect

- The balance display is not set to zero
- Adjustment is no longer correct.
- Great fluctuations in temperature.
- Electromagnetic fields / static charging (choose different location/switch off interfering device if possible)

Switch the balance off if other error messages should appear and then switch on again. Contact the manufacturer if the error message does not disappear.