

TENMARS

TACHO Meter TM- 4100N/TM- 4100DN User's Manual

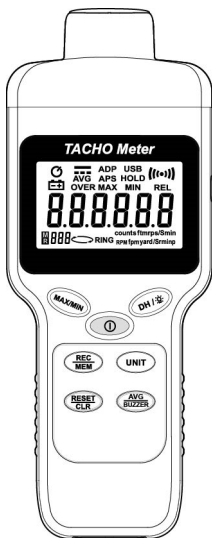

HB2TM4100N00

Contents

1	Introduction	3
2	Accessories.....	3
3	Safety.....	3
4	Instrument Description.....	4
4.1	Meter Description	4
4.2	LCD Description.....	5
5	General Specifications.....	6
6	Electrical Specification.....	8
7	Operation	9
7.1	Power on/off	9
7.2	Auto power off	9
7.3	Data Hold	9
7.4	Backlight	9
7.5	Average (AVG)	9
7.6	Buzzer on/off	10
7.7	Unit	10
7.8	MAX/MIN.....	10
7.9	Reset (RESET/CLR).....	11
7.10	Save single record manually (REC key)	11
7.11	Reading memory	12
7.12	Clear memory.....	12
7.13	Precautions on tachometer measurement	12
7.13.1	Noncontact speed measurement mode.....	13
7.13.2	Contact tachometer (optional).....	14
8	Setup Mode.....	15
8.1	St1 (Auto Power On/Off).....	15
8.2	St2 (Auto Power Off Timer).....	15
8.3	St3 (Data Logger Interval)	16
8.4	St4 (Backlight Timer)	16
8.5	St5 (Units)	17
9	Maintenance or Repair.....	17
10	Battery replacement.....	18
11	Product disposal.....	18

1 Introduction



This is a handheld tachometer for both contact and non-contact measurement.

It is ideal for measuring rotational speeds of machines, motors and conveyor belts and for counting the moving objects.

2 Accessories

- 1 Meter
- 1 Contact set (optional)
- 1 User's Manual
- 1 9V alkaline Battery
- 1 Carrying case
- 1 USB cable and installation disk (TM-4100DN)
- 2 Reflection tape

3 Safety

	Caution! Please refer to this manual. Improper use may damage the meter and its components.
	Complies with European Directive.

- Do not operate in environments with flammable gas or humid environments.
- Operating altitude: up to 2000M.
- Operating environment: Indoor use, Pollution degree 2.
- Clean with soft cloth when dirty, such as glasses cloth. Do not clean with chemicals and other solvents.
- EMC: EN61326-1: CISPR 11: Group 1, Class B
 - ◇ Class B – Equipment for use in all establishments other than domestic.
 - ◇ Group 1 – RF energy generated is needed for internal functioning.

4 Instrument Description

4.1 Meter Description

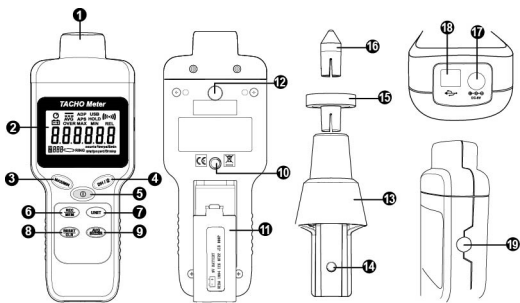

- | | |
|------------------------|-----------------------------------|
| 1. Sensor | 12. Contact adaptor mounting nut |
| 2. LCD | 13. Contact adaptor |
| 3. MAX/MIN | 14. Fixed screw |
| 4. Data Hold/Backlight | 15. Circular X 0.1M contact probe |
| 5. Power | 16. Contact tip |
| 6. REC / MEM | 17. Power port (TM-4100DN) |
| 7. UNIT | 18. USB port (TM-4100DN) |
| 8. Clear readings | 19. RS-232 port (TM-4100DN) |
| 9. AVG / Buzzer | |
| 10. Tripod unit | |
| 11. Battery cover | |

4.2 LCD Description

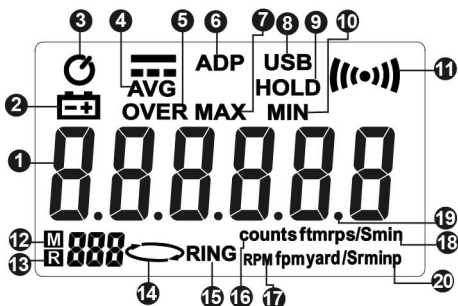

- | | |
|-----------------------|---|
| 1. Display | 11. Buzzer symbol |
| 2. Low battery | 12. M-Memory |
| 3. Auto power off | 13. R- Record |
| 4. AVG | 14.  -Contact indication |
| 5. OVER | 15. RING Symbol |
| 6. AC power indicator | 16. Unit of counts |
| 7. Maximum hold | 17. RPM (r/min) |
| 8. USB indicator | 18. r/s; r/min; ms; m/s;
m/min; ft/min |
| 9. Data Hold | 19. Point |
| 10. Minimum hold | 20. yard/min |



5 General Specifications

- Display:6 digits LCD display with maximum 999999.
- Noncontact IR and contact measurements.
- Range of noncontact measurement: 50~500mm.
- Sampling rate

>60 rpm	12 ~ 60 rpm	Average
0.5 sec.	>1 sec.	>2 sec.

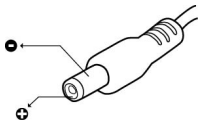
- Functions: maximum/minimum values, data hold, average value, auto power off, buzzer, backlight
- Manual recording: 200 data (TM-4100N)
20,000 data (TM-4100DN)
- Auto recording: 200 data (TM-4100N)
20,000 data (TM-4100DN)
- Battery life: about 20 hours (with continuous measurement and buzzer off)
- Power: 9V (NEDA 1604 IEC 6F22 JIS 006P) x 1
- External power supply(TM-4100DN)
 - 1.Support USB power input
 - 2.Optional adaptor:
 - Adaptor: AC 100~240V to DC 9V/0.5A
 - Plug: The center pin: +
The shell:–
 - O.D.: 5.5mm; I.D.: 2.1mm



- Low battery voltage measurement 
- The “**ADP**” appears on the LCD and auto power off function is disabled when the meter is connected with power adaptor.
- The “**USB**” appears on the LCD and the auto power off function is disabled when the meter is connected to pc with a USB cable.
- The “  ” appears on the LCD when the contact connector is mounted on the meter.
- The “**RING**” appears on the LCD when the reflected IR light is received.
- RS-232 port instruction (TM-4100DN):
Output: Earphone port (Diameter 3.5mm/4 plug head).

Output voltage: 3.3V (LVTTTL). See below.

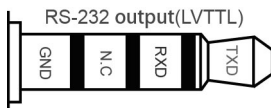

- Dimensions: 186x70 x36 mm (L x W x H).
- Weight: Approx 230g (battery included)
- Operating temperature and humidity range:
0°C ~ +50°C, <80%RH.
- Storage temperatures and humidity range:
0°C ~ +60°C, <70%RH.

6 Electrical Specification

Accuracy is indicated as [% rdg + dgt]

ambient temperature range: 18°C (64°F) ~ 28°C (82°F)

Noncontact

Unit	RPM/count measurement	Resolution	Accuracy
RPM r/min	12.00 ~ 99960	0.01/0.1/1	±0.04%±2dgt.
RPM r/s	0.2000 ~ 1666.0	0.0001/0.001/ 0.01/0.1	
Cycle ms	0.6000 ~ 5000	0.0001/0.001/ 0.01/1	
Counts	0 ~ 999999	1	±1dgt ~±20dgt.

Contact

Unit	RPM/count measurement	Resolution	Accuracy
RPM r/min	12.00 ~ 19980	0.01/0.1/1	±0.04%±2dgt.
RPM r/s	0.2000 ~ 333.0	0.0001/0.001/ 0.01/0.1	
ft/min	3.937 ~ 6555	0.001/0.01/0.1/	
yard/min	1.312 ~ 2185	1	
m/min	1.200 ~ 1998.0	0.001/0.01/0.1	
m/s	0.0200 ~ 33.30	0.0001/0.001/ 0.01	
Cycle	3.000 ~ 5000	0.001/0.01/0.1/ 1	
Counts	0 ~ 999999	1	±1dgt~±20dgt.

1 foot / minute = 0.00508 m / s = 0.3048 m / min



1 yard / minute = 0.01524 m / s = 0.9144 m / min

7 Operation



7.1 Power on/off

Press “  ” to turn the power on or off.

7.2 Auto power off

Turn on the meter, press and hold “  ” for more than 2 seconds to enable/disable the auto power off function. When the auto power off is enabled, “  ” appears on the LCD.

7.3 Data Hold

Press “  ” to hold readings on the LCD and “ **HOLD** ” is displayed, press “  ” again to disable data hold.

7.4 Backlight



Press and hold “  ” for more than 2 seconds to turn the backlight on or off.

The backlight will automatically turn off after being lit for 30 seconds.

7.5 Average (AVG)

Press “  ” to enable / disable the average function; use this function is for getting a more stable readings for unstable measurement values.

7.6 Buzzer on/off

Press and hold “  ” for more than 2 seconds to turn on or off the buzzer (the “  ” appears on the LCD when buzzer is on). It sounds once for each object counted (noncontact measurements) and twice for each lap counted (contact measurements).

7.7 Unit

Press “  ” repeatedly to change the units.

■ Noncontact measurement:



RPM r/min → r/s → ms → counts

■ Contact measurement: “  ” appears on the LCD

Metric: RPM r/min → r/s → ms → counts → m/s → m/min

Imperial: r/min → r/s → ms → counts → ft/min → yard/min

7.8 MAX/MIN



■ Press “  ” repeatedly to select the displayed reading of **MIN** and **MAX**, press and hold the “  ” for more than 2 seconds to exit this function.

Note: This function can hold and update the maximum and minimum values out of measurement history and is unavailable in counter mode.

7.9 Reset (RESET/CLR)

Press “  ” to clear the measurement values in “MAX/MIN” and “counts” mode.

7.10 Save single record manually (REC key)

Press “  ”, “R” and the record number appears on the LCD. Press the “  ” again to record a new data .

TM-4100N: The record number is shown in the lower left corner of LCD with small font.

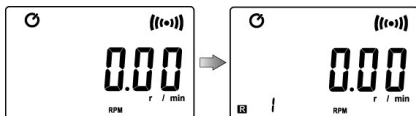



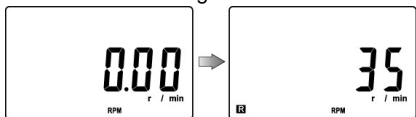

TM-4100DN: The record number is shown in the right side on LCD with large font.

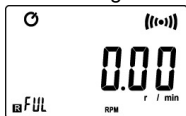

When memory space is full, “FUL” will be displayed in the lower right corner.





7.11 Reading memory

Press and hold “  ” more than 2 seconds to enter the reading memory mode, press “  ” or “  ” to read the data, press and hold “  ” for more than 2 seconds exit the mode.

Note: When reading memory from TM4100DN, the number of data shown first, then shown the data of memory.

7.12 Clear memory

In the reading memory mode, press and hold “  ” for more than 2 seconds until “ **CL** ” flashes, press “  ” to clear the memory.

7.13 Precautions on tachometer measurement

This is a handheld tachometer that emits and receives reflected LED light for the measurement of both contact and non-contact mode. It measures rotational speeds and counts the moving objects with data hold, maximum, minimum and average functions.

7.13.1 Noncontact speed measurement mode

Take a tape (10mmx10mm in dimension), stick the tape on outeredge of measurement object, then press “ **UNIT** ” to selet units. Point the LED light to the tape until value displayed.

It may count moving objects as well. Press the “ **RESET CLR** ” to clear counter values and reset the counter.

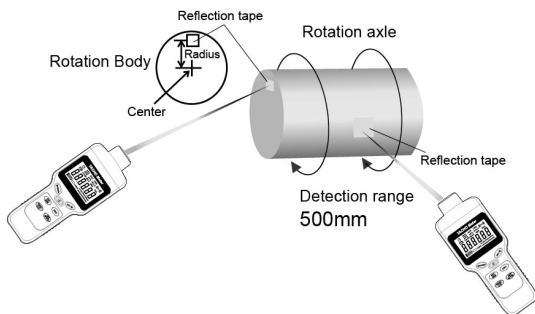

7.13.2 Contact tachometer (optional)

Insert the contact connector and screw it on the meter's sensor port. The icon "  " appears on the LCD. DO NOT press the connector hard for safety concern

Press the "  " to select the proper unit for the following measurement.

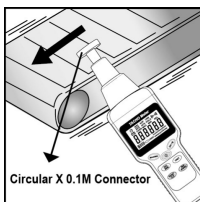

- Insert x0.1M probe surface speed measurement (m/s, m/min, ft/min, yard/min)

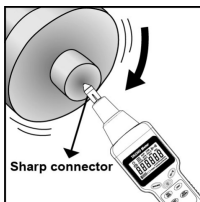

- Insert sharp connector for motor speed measurement (r/min, r/s, ms, counts)



Note:





It takes more time to display rpm values at lower speeds, e.g. 5 seconds for 12rpm and 1 second for 60rpm.



Warning!



The "OVER" indicator displays when speed is measured by a contact connector at over 19,999rpm. Stop operating the meter immediately.

8 Setup Mode

Press and hold both “” and “” together until “**St 1**” appears on the LCD, press “” repeatedly to select the functions (**St 1** ~ **St 5**) in sequence; press “” again to exit the setup mode.

See 8.1~8.5 to set up.

8.1 St1 (Auto Power On/Off)



Press “” or “” to select auto power “**ON**” or “**OFF**”.

Note: This function does not work when the meter is connected to a power adaptor or USB cable.

8.2 St2 (Auto Power Off Timer)

Press the “” or “” to select the hour or minutes.



hour min
00.00
St 2

Press “” or “” to increase or decrease the numbers. Default time is 5 minutes and the range is from 5 minutes to 99 hours and 59 minutes.

8.3 St3 (Data Logger Interval)

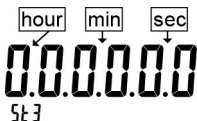

Press “  ” or “  ” to select hour, minute, and second.



Press “  ” or “  ” to increase or decrease the numbers. Default time is 0 (no auto recording), and the range of interval time is from 10 seconds to 23 hours, 59 minutes, and 59 seconds.

(The interval time reset to 0 when you restart the meter).

8.4 St4 (Backlight Timer)

Press “  ” or “  ” to increase or decrease by 30 seconds each time and select the following timers in sequences:

00.30>>01.00>>01.30>>02.00>>02.30>>03.00>>03.30
>>04.00>>04.30>>05.00.

Default time is 30 seconds and the rang is from 30 seconds to 5 minutes.

8.5 St5 (Units)

Press “  ” or “  ” to select imperial or metric unit.

Imperial and metric units are validated when contact connector is mounted and “  ” appears on the LCD.

5Ł5  5Ł5
(Imperial)

(Metric)

9 Maintenance or Repair

1. Replace battery immediately when the LCD displays  .
2. If dirty, please wipe it with a soft cloth, such as glass cleaning cloth, and not use a solvent such as chemical.
3. Remove the battery out of the meter when it will not be used for longer than one month. In order to prevent battery leakage and causing damages to internal component.
4. In fault on the meter, it can only be sent to the authorized service suppliers or sent back to the original factory for maintenance.

10 Battery replacement



warning

If the symbol “  ” appears on the LCD, please replace the battery immediately

- Turn off the power.
- Open the battery cover at the back of the meter, remove the battery.
- Please insert a new 9V battery according to the polarities.
- Put the battery cover back in place.

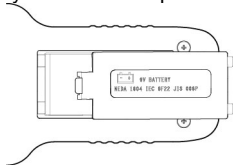

11 Product disposal



Note: This symbol indicates that the meter and its accessories must be separated and processed properly.



TENMARS



**Professional Electrical and Environment Test &
Measurement Instruments:**

LED light meter, Temperature & Humidity meter, Infrared Thermometer, Sound level meter, Light meter, EMF meter, UV Light meter, RF meter, Hot wire Anemometer, Co meter, Anemometer, Lan cable tester, Co2 meter, Solar power meter, Radiation meter, Clamp meter, Multimeter, Phase Rotation test, Digital Insulation tester

**Our products of high quality are selling well all
over the world**

**TENMARS ELECTRONICS CO., LTD.
6F, NO.586 Ruiguang Rd, Neihu Dist.
Taipei City, Taiwan
E-mail: service@tenmars.com
<http://www.tenmars.com>**