

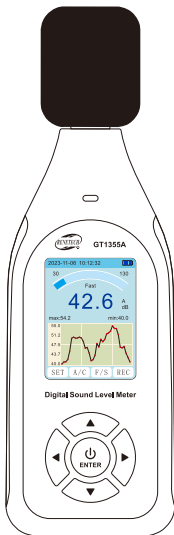

MODEL: GT1355A

Sound Level Meter Instruction Manual



Contents

I. Product introduction

A. Introduce.....	1
B. Features.....	1
C. Component names and button functions.....	2
D. Specifications.....	3
E. Calibration.....	4

II. Operation instructions

A. Power on/off.....	5
B. Data HOLD.....	5
C. A/C Frequency weighting selection.....	5
D. F/S Time weighting selection.....	5
E. Data Record.....	6
F. SET.....	7
1. Language.....	7
2. Date&time.....	7
3. Auto off.....	7
4. Light alarm.....	8
5. Save data.....	8
6. Read data.....	9
7. Delete data.....	9
8. Reset default.....	9

III. PC software

A. Requirements of computer configuration.....	10
B. Software download.....	10
C. Connection status.....	11
D. Software instruction.....	11

IV. Other

A. Attentions.....	16
B. Maintenance.....	16

I. Product introduction

A. Introduce

This Sound Level Meter has been designed to meet the measurement requirement of noise engineers, noise quality control and health prevention in various environments, such as noise measurement in factory, office, traffic road, family and all other noise measurement applications.

B. Features

1. A/C Frequency weighting selection
2. Fast/Slow Time weighting selection
3. Three-color light alarm
4. Maximum/Minimum
5. Data HOLD
6. Data storage: 43,000 data record function
7. Data Read and Delete
8. Automatic shutdown time can be set, and automatic shutdown when battery runs out
9. Display date and time
10. Line chart: Visual display of noise data changes
11. USB charging and PC communication: Connect with the PC through USB, provides data record download, real-time data sampling analysis, and printing graph&data functions.
12. This Sound Level Meter was designed according to following standards:
 - a. International electrician committee standard: IEC PUB 651 TYPE2
 - b. US national standard: ANSI S1.4 TYPE2

C. Component name and button function

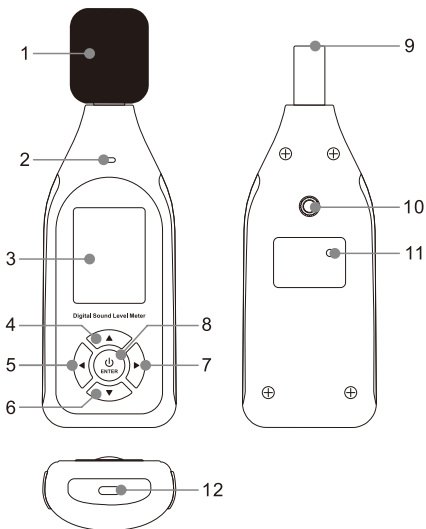

1. Sponge ball (when outdoor use please put on, prevent wind blowing noise disturbing the unit reading)
2. Alarm light
3. LCD display
4. Up button: Value increase / Move up / Data HOLD
5. Left button: Go back to the previous step / Shrink the line chart / Left select the data bits
6. Down button: Value increase reduce / Move down
7. Right button: Go to the next step/Enlarge the line chart/Right select the data bits
8. Middle button: Power on/off / Confirm / Go to the next step
9. Capacitance microphone
10. Tripod fixed screw aperture
11. Calibration knob
12. Type-C interface

D. Specifications

Calibration sound source	94dB@1KHz
Measurement range	30~130 dB(A), 35~130dB(C)
Accuracy	±1.5dB(Reference sound pressure standard,94dB@1KHz)
Resolution	0.1dB
Frequency weighting	A/C
Frequency response	31.5Hz~8500Hz
Time weighting	FAST/SLOW
Sampling rate	FAST: 8 times/second SLOW: 1 times/second
Rated current	70mA
Standby current	5uA
Power supply	3.7V lithium battery /1000mAh
Charging time	1.5h
Duration of service	8h
Data storage	43,000
Microphone	1/2-inch polarization capacitance microphone
Operating temperature	0~50°C
Operating humidity	10~80%RH
Dimension	160*56*31mm(Excluding sponge ball)
Weight	Approx 120g(Excluding sponge ball)

E. Calibration

1. Please use 94dB@1KHZ standard calibration instrument
2. Setting on sound level meter: Frequency weighting is A, Time weighting is FAST
3. Insert the microphone carefully into a 1/2-inch hole in the standard audio source (94dB@1KHz).
4. Turn on the power switch of the standard sound source, adjust the potentiometer at the circular hole in the battery door with slotted screwdriver, and make the LCD display 94.0

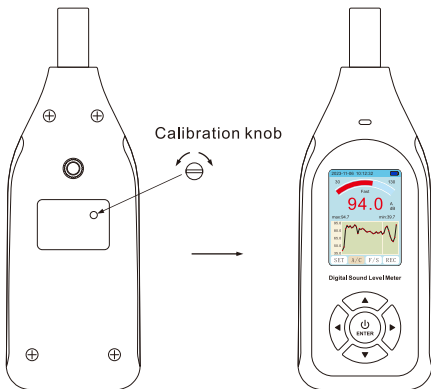

Note:

Our products are all well calibrated before Shipment.

Recommended recalibration cycle: 1 year.

II. Operation instructions

A. Power on/off

Power off status, short press the Middle button to turn on; Power on status, long press the Middle button to turn off.

B. Data HOLD

On the measurement interface, short press the Up button to display [HOLD] data lock; Short press the Up button again to release the data, [HOLD] disappears, and continue measuring.

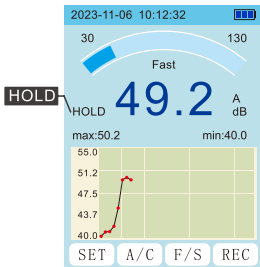

C. A/C Frequency weighting selection

On the measurement interface, short press the Left/Right button to select "A/C", short press the Middle button to switch between A/C A-Weighting for general sound level measurements.
C-Weighting for checking the low-frequency content of sounds.

D. F/S Time weighting selection

On the measurement interface, short press the Left/Right button to select "F/S", short press the Middle button to switch between FAST/ SLOW.

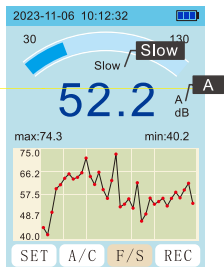
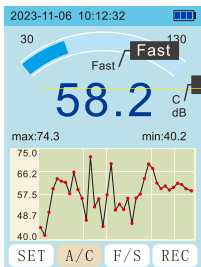

On the measurement interface, short press the Left/Right button to select the line chart, short press the Left/Right button to shrink or enlarge the line chart, and short press the Middle or down button to return to the measurement state.

E. Data Record

On the measurement interface, short press the Left/Right button to select "REC", short press the Middle button to enable real-time recording of noise data, displaying [recording...], then short press the Middle button again to save the recording and exit.

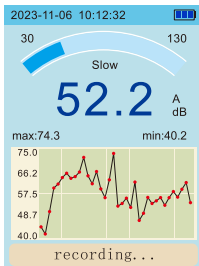

F. SET

On the measurement interface, the Left/Right button to select "SET", short press the Middle button to enter the settings main page, the Up/Down button to select the settings item, Centre or Right button to enter the secondary page, and the Left button to return to the main page:

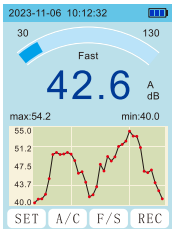

Measurement Interface



Settings main page

1. language

The Up/Down button to select "Chinese/English", short press the Middle button to enter, short press Left button to return to the main page.

2. date&time

The Up/Down button to select "year/month/day/hour/minute/second", short press the Middle button to enter, press the Up/Down button again to adjust the value, short press Left button to return to the main page.

3. auto off (Automatic shutdown):

The Up/Down button switching options: Weather to turn on automatic shutdown, Set automatic shutdown time;

(1) Whether to turn on automatic shutdown: short press the Middle button to turn on/off;

(2) Set automatic shutdown time: short press the Middle button to select, short press the Left/Right button to select the digits, and short press the Up/Down button to adjust the value;

(3) Automatic shutdown range: 0001~9999 minutes;

4. light alarm(Alarm setting):

The Up/Down button switching options: Whether to turn on light alarm, High/low alarm value;

- (1) Whether to turn on the light alarm: short press the Middle button to turn on/off;
- (2) High/low alarm value setting: short press the Middle button to select, short press the Left/Right button to select the digit, and short press the Up/Down button to adjust the value;
- (3) Three-color light alarm: Green: does not exceed the high/low alarm value; Yellow: exceed the low alarm value; Red: exceed the high alarm value;
- (4) Alarm value setting range: 30~130dB, and can only be set successfully when the high alarm value is greater than the low alarm value;

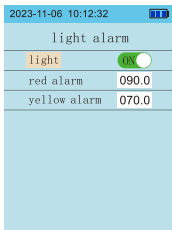

Alarm setting

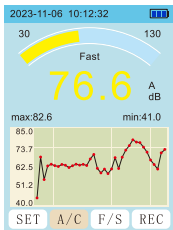

Yellow: Exceed the low alarm value

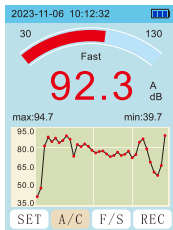

Red: Exceed the high alarm value

5. save data(Saving setting):

The Up/Down button switching options: Whether to start recording, Record interval, Record group number;

- (1) Whether to start recording: short press the Middle button to open/close; After starting recording, automatically return to the measurement interface and start recording;
- (2) Record interval: short press the Middle button to select, short press the Left/Right button to select the digit, and short press the Up/Down button to adjust the value; Range: 01~99 seconds;
- (3) Set record group number: short press the Middle button to select, short press the Left/Right button to select the digits, and short press the

III. PC software

A. Requirements of computer configuration

1. CPU: Pentium III 600MHZ or above
2. One free available USB connecting interface
3. The lowest screen resolution of monitor is 800*600 (or much higher), true color
4. At least 8MB available memory
5. At least 50MB available disk memory
6. Operation system: Windows 10.

B. Software download

Enter the website "www.benetechno.net" in the browser, press enter and enter the page to find the menu "Support"->"Download Catalog". Click into the page to find the software installation package "SoundLab.zip". Click the download button to directly extract the "zip package" after downloading. Double click on "SoundLabSetup.exe" to install.

C. Connection status

1. Connected to device:

"Connected" appears in the bottom left corner of the PC;

"USB" appears on the left side of the product screen.

2. Disconnected to device:

"Disconnected" is displayed in the bottom left corner of the PC;

"USB" is not displayed on the left side of the product screen.

Connected

PC

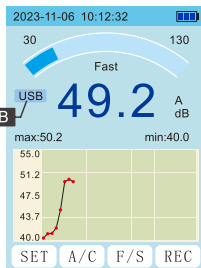

Product screen





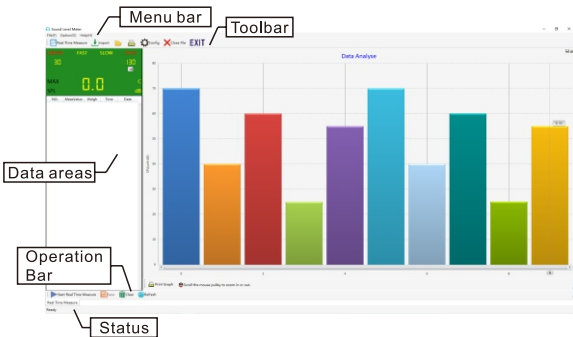

D. Software instruction

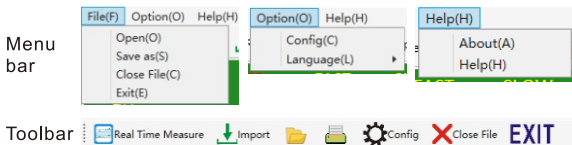
1. Software window:



2. Menu bar/Toolbar:



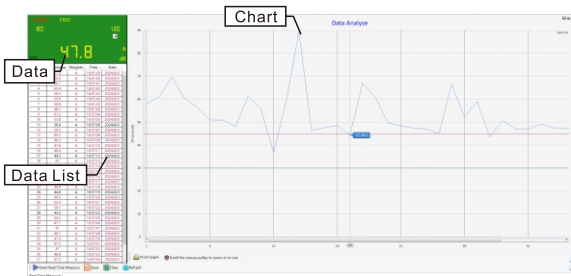

Menu bar	Toolbar	Function
Open		Open a stored .xls measurement data file
Save as	-	Save real-time measurement data as a separate .xls file
Close File		Close the current page
Exit	EXIT	Exit PC software
Config		Setting instrument and software related parameters
Language	-	English, Simplified, Traditional Chinese, Japanese
About	-	Software version description
Help	-	Software problem feedback
-		Real-time data measurement
-		Import the measurement data saved by the product into PC software
-		Print data sheet

3. Data areas:



1) Data:

- Display current data or real-time measurement of the last data;
- Frequency/range/unit and other parameters are updated synchronously with product Settings;
- Click  to display the current noise value in full screen. Click  to exit the full screen.

2) Data list:

- Display detailed parameters of all measurement data;
- Black: does not exceed the alarm value; Red: exceeds the high alarm value; Green: below the low alarm value;

3) Chart:

- Horizontal coordinate: data serial number; Ordinate: Noise value;
- When the mouse moves to the chart, the data is displayed: serial number, noise value;
- Scroll the mouse to zoom the polyline, at this time, "back" and "full display" appear on the top right, click back to the previous step change, full display will display the zoom to display all data;
- Charts can be saved/printed on the top right.

4. System Config: Setting instrument and software related parameters.

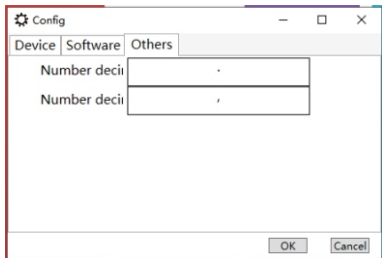
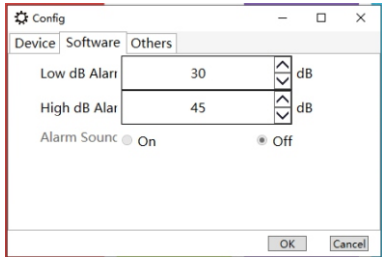
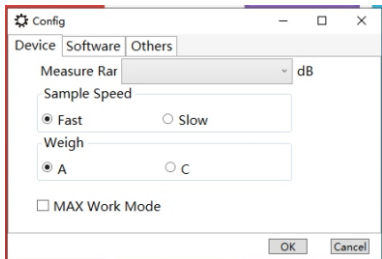

5. Real Time Measure

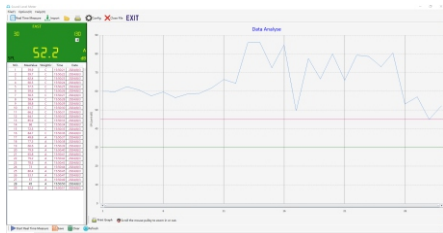

Operation Bar	Function
Start Real Time Measure	Click to start Real Time Measure
Stop Real Time Measure	Click to stop Real Time Measure
Save	Storage of real-time measurement data, file format: .xls
Clear	Click to clear all the measuring data
Refresh	Click this button to refresh after updating high/ low alarm values

* When the real-time measurement starts, if the product is not connected or the contact is poor, the "Device is not connected" window will pop up. Please reconnect or change to another USB port.

6. Import data

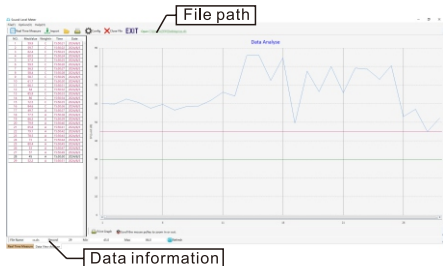

IV. Other

A. Attentions

1. Environment conditions on operation:
 - (1) 2000 meters high below;
 - (2) Temperature: 0~40°C ;
 - (3) Relative humidity: ≤80%RH
2. Do not store or use the unit in following conditions:
 - (1) Splashes of water or high levels of dust.
 - (2) Air with high salt or sulphur content.
 - (3) Air with other gases or chemical materials.
 - (4) High temperature or humidity or direct sunlight.
3. Never impact the unit or used on humidity conditions.

B. Maintenance

1. Maintenance of battery:
 - (1) When you do not use this product for a long time, you need to charge it once a month to avoid affecting the battery life.
 - (2) When the screen power displays [] after turning on, please charge in time. After the battery runs out, there is a 10-second countdown to the left of the battery symbol. After that, it will automatically shut down.
2. Cleaning the casing:

Never use alcohol or thinner to clean the unit casing that will especially erode the LCD surface; just clean the unit lightly as needed with little clean water.



Specific Declarations

- a. We reserve the rights of the update and amendment of the product design and the manual which are subject to change without further notification.
- b. Dispose of battery should in accordance with local laws and regulations.
- c. Our company shall hold no any responsibility resulting from using output from this product as an direct or indirect evidence.

